

ROK

Východočeské muzeum
v Pardubicích

185

8501/13



850 028

PETR HORA

8502/18



850033

P. HORA

8502/25

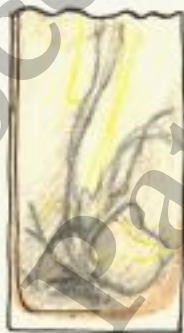

850 024

P. HORA

85 05/18



850 023

P. HORA

8507/30

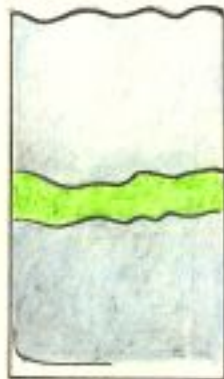

A - parouk
B - NITE

850 002

8515/12



850 003

J. SVOBODA

8515/23



850 008

8515/24



850 007

8515/38



850 004

8516/26



850 001

8517

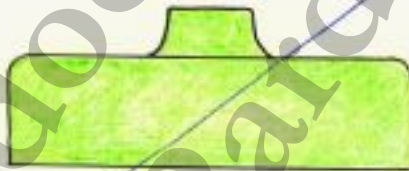

850 002

8518/25

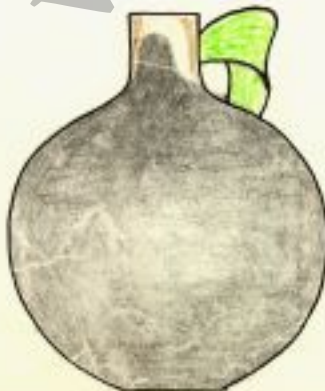

850 025

P. HORA

8519/16



850 026

8519/26

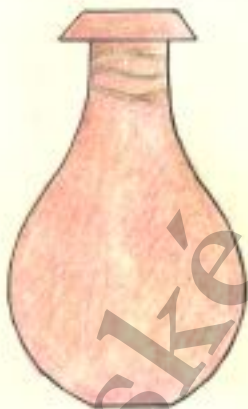

850 027

P. HORA

8520/9



850 009

J. SVOBODA

8521/14



850 010

8524/13

15



850 013

ROUBÍČEK

8525/10



850 014

dně

8526/11

KB



850 015

8527/10

16



850 016

8528/6

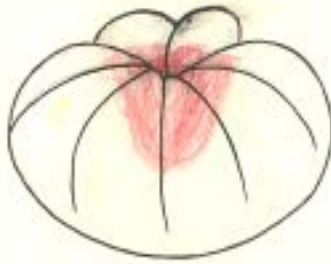

850 017

8529/11



850 018

8530/11



850 016

8531/14



850 021

Východočeské muzeum
v Pardubicích

8531/17



850 020

8532/22



ROUBÍČEK

8532/27



ROUBÍČEK

8533/22



JUDA

8533/13



JUDA

8533/12

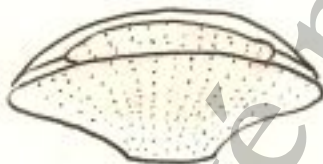

JUDA

8533/18



JUDA

8534/30
/40

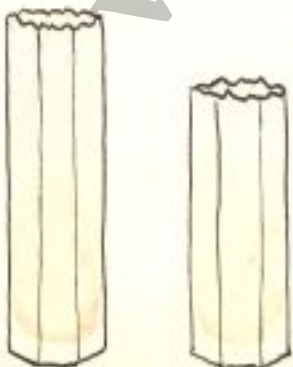

SVOBODA

8535/30

/40

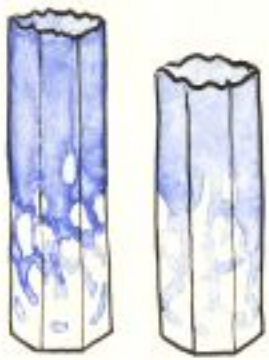

J. SVOBODA

8536/30

/40

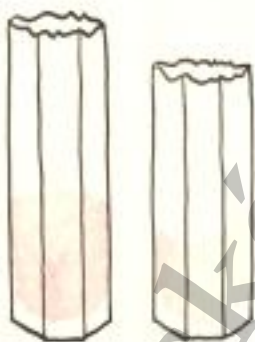







Východočeské muzeum
v Pardubicích

Východočeské muzeum
 v Pardubicích

ROK

1886

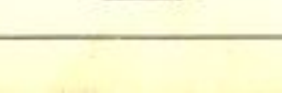
8603/37		FORMA Z+KŘ. ROPAL WEIS JAN EXNAR
860 252		FORMA T+KŘ. R.OPAL WEIS JAN EXNAR
8601/15		FORMA T+KŘ. R.OPAL WEIS JAN EXNAR
860 250		FORMA OPAL HIMBEGR +OPAL WEIS +KŘ. JAN EXNAR
8602/13		FORMA OPAL HIMBEGR +OPAL WEIS +KŘ. JAN EXNAR
860 251		FORMA OPAL HIMBEGR +OPAL WEIS +KŘ. JAN EXNAR
8604/13		FORMA OPAL HIMBEGR +OPAL WEIS +KŘ. JAN EXNAR
860 253		FORMA OPAL HIMBEGR +OPAL WEIS +KŘ. JAN EXNAR

Východočeské muzeum
 v Pardubicích

8605 / 12



R.OPAL ROTT
GELBLICH +
TOPAS KRĚ.

860 254

**JAN
EXNAR**

8606 / 28



M.+KRĚ.+ZEL.

860 255

**JAROSLAV
SVOBODA**



KŘ.+TOP.
ZEL.+KŘ.
TOP.+KŘ.+ZEL.
M.+TOP.+KŘ.

8607 / 19
724

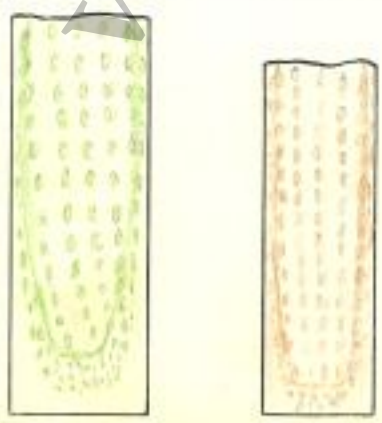



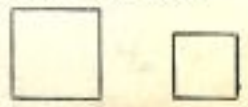



KŘ. ZELENÁ
KŘ. TOPAS

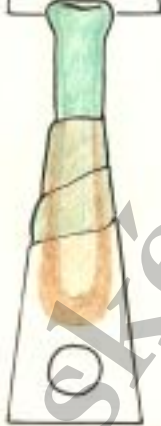





860 256

**JAROSLAV
SVOBODA**

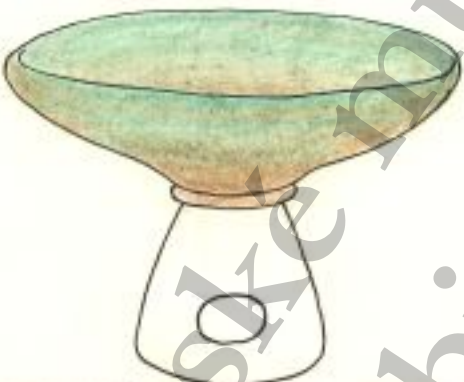
<p>8608 / 32</p>		<p>ZEL.+TOP.+KR.</p> <p>JAROSLAV SVOBODA</p>
<p>860 257</p>		<p>ZEL.+TOP.+KR.</p> <p>JAROSLAV SVOBODA</p>
<p>8608 / 27</p>		<p>ZEL.+TOP.+KR.</p> <p>JAROSLAV SVOBODA</p>
<p>860 258</p>		<p>ZEL.+TOP.+KR.</p> <p>JAROSLAV SVOBODA</p>
<p>8608 / 20</p>		<p>ZEL.+TOP.+KR.</p> <p>JAROSLAV SVOBODA</p>
<p>860 259</p>		<p>ZEL.+TOP.+KR.</p> <p>JAROSLAV SVOBODA</p>
<p>8608 / 16</p>		<p>ZEL.+TOP.+KR.</p> <p>JAROSLAV SVOBODA</p>
<p>860 260</p>		<p>ZEL.+TOP.+KR.</p> <p>JAROSLAV SVOBODA</p>

Východočeské muzeum
v Pardubicích

<p>8608/11</p> <p>860 261</p>		<p>ZEL.+TOP.+KRŮ.</p> <p>JAROSLAV SVOBODA</p>
<p>8608/21</p> <p>860 262</p>		<p>ZEL.+TOP.+KRŮ.</p> <p>JAROSLAV SVOBODA</p>
<p>8609/30</p> <p>860 263</p>		<p>LIMELECE</p> <p>KRŮ.+TOP.+ ZELENÁ</p> <p>JAROSLAV SVOBODA</p>
<p>8610/12</p> <p>860 264</p>		<p>KRŮ.</p> <p>FRANTIŠEK VÍZNER</p>

<p>8610/23</p> <p>860 265</p>		<p>KŘ.</p> <p>FRANTIŠEK VÍZNER</p>
<p>8610/30</p> <p>860 266</p>		<p>KŘ.</p> <p>FRANTIŠEK VÍZNER</p>
<p>8611/32</p> <p>860 267</p>		<p>KŘ.</p> <p>FRANTIŠEK VÍZNER</p>
<p>8611/24</p> <p>860 268</p>		<p>KŘ.</p> <p>FRANTIŠEK VÍZNER</p>

Východočeské muzeum
V Jarodubířích

8612/20



KŘ.

860 269

**FRANTIŠEK
VÍZNER**

8613/18



KŘ.

860 270

**FRANTIŠEK
VÍZNER**

8614/17



KŘ.

860 271

**FRANTIŠEK
VÍZNER**

8615/28



KŘ. ZEL.

860 272

**FRANTIŠEK
VÍZNER**

8615/ 12



KŘ. ZEL.

š. = 17

**FRANTIŠEK
VIŽNER**

860 273

8616 /15

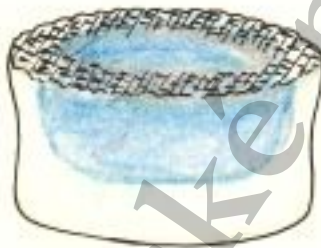

SATTBLAU+KŘ.

PETR HORA

860 274

8616/ 18



SATTBLAU+KŘ.

PETR HORA

860 275

8616/14



SATTBLAU+KŘ.

PETR HORA

860 276

8616/25



OPALWEIS+KR^Ů

860 301

PETR HORA

8616/10



SATTBLAU+KR^Ů

860 277

PETR HORA

8617/26



HELLBEIGE+
TOP.

860 278

PETR HORA

8618/18



HELLBEIGE +
TOP.

860 279

PETR HORA

8619 / 28/4



OPAL
R. RAUCHGRAU +
SODA + KR.

860 280

PETR HORA

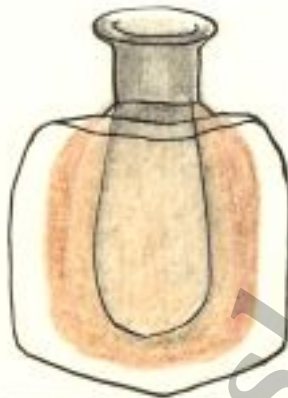

3x R. OPAL NIL-
GRÜN
1. RAUCHGRAU +
TOP + KR.
2. RAUCHGRAU +
OPAL WEIS +
OPAL GRAU +
OPAL ROTT

8620 / 30



OPAL BLAU-
GRAU + TOP + KR.

860 281

PETR HORA

8621 / 24



TOP + KR.

860 282

PETR HORA

8622/19



TOP. + KRŮ.

860 283

PĚTR HORA

8623/19
28



OPAL
BLAUGRAU +
TOPAS + KRŮ.

860 284

PĚTR HORA



1 KRŮ + ZEL.
2 KRŮ + PLAUCNA
ČERVENÁ
3 KRŮ + OPAL WEIS
+ OPAL GRAU
+ OPAL ROTT

8624/10/13

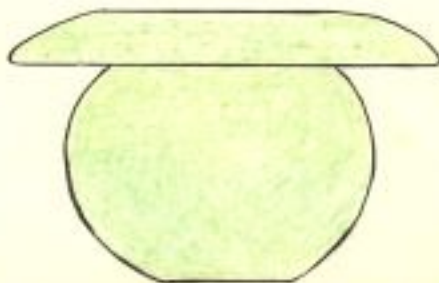

KRŮ. ZEL.

860 285

**JAROMÍR
RYBÁK**

8625/12



KŘ. TOPAS

**JAROMÍR
RYBÁK**

860 286

9 cm

8626/16 *6.*

NEUBLAU+KŘ.



**MILAN
HANDL**

860 287

9,5 cm

8626/14

NEUBLAU+KŘ.



**MILAN
HANDL**

860 288

9,5 cm

8626/8
v=8, s=14

NEUBLAU+KŘ.

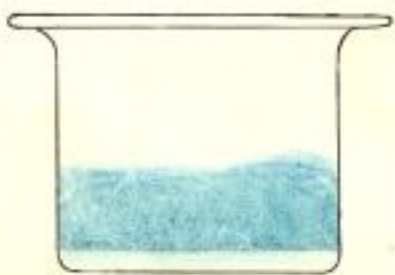



**MILAN
HANDL**

860 289

10 cm

<p>8626/11 v=11, š=16</p> <p>860 290</p>	 <p>11,5</p>	<p>NEUBLAU+KŘ.</p> <p>MILAN HANDL</p>
<p>8626/12 v=12, š=12</p> <p>860 291</p>	 <p>8 cm</p>	<p>NEUBLAU+KŘ.</p> <p>MILAN HANDL</p>
<p>8627/17</p> <p>860 292</p>	 <p>8 cm</p>	<p>OPAL WEIS + KŘ.</p> <p>MILAN HANDL</p>
<p>8628/18</p> <p>860 293</p>	 <p>10 cm</p>	<p>OPAL WEIS + KŘ.</p> <p>MILAN HANDL</p>

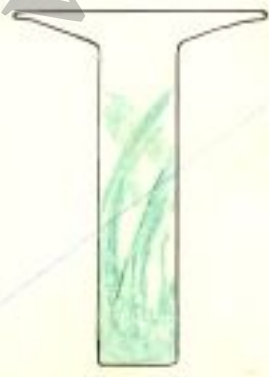
<p>8629 / 17</p> <p>860 294</p>		<p>KŘZEL. + KŘ. TOP.</p> <p>ILJA BÍLEK</p>
<p>8630 / 17</p> <p>860 295</p>		<p>KŘ+ TOP.</p> <p>ILJA BÍLEK</p>
<p>8631 / 18</p> <p>860 296</p>		<p>KŘ.</p> <p>ILJA BÍLEK</p>
<p>8632 / 17</p> <p>860 297</p>		<p>KŘ.</p> <p>ILJA BÍLEK</p>

Východočeské muzeum
v Pardubicích

8633 / 14



AKVAMARIN +
KŘ.

860 298

**MILAN
NOSEK**

8633 / 12



AKVAMARIN +
KŘ.

860 299

**MILAN
NOSEK**

8634 /

9105 / 10 10



KŘ.

860 300

**RUDOLF
BERÁNEK**

8635 / 21



860 301

Východočeské muzeum
Pardubicích

8636/21



860 302

8637/15



860 303

8638/19



860 304

BERÁNEK P.

8639/10



860 305

Východočeské muzeum
v Pardubicích

24
8640 / 8



860 306

7911 / 12



860 307

PETR HORA

Východočeské muzeum
v Pardubicích